

## Chain link fence install instruction

### Method 1 : Before You install

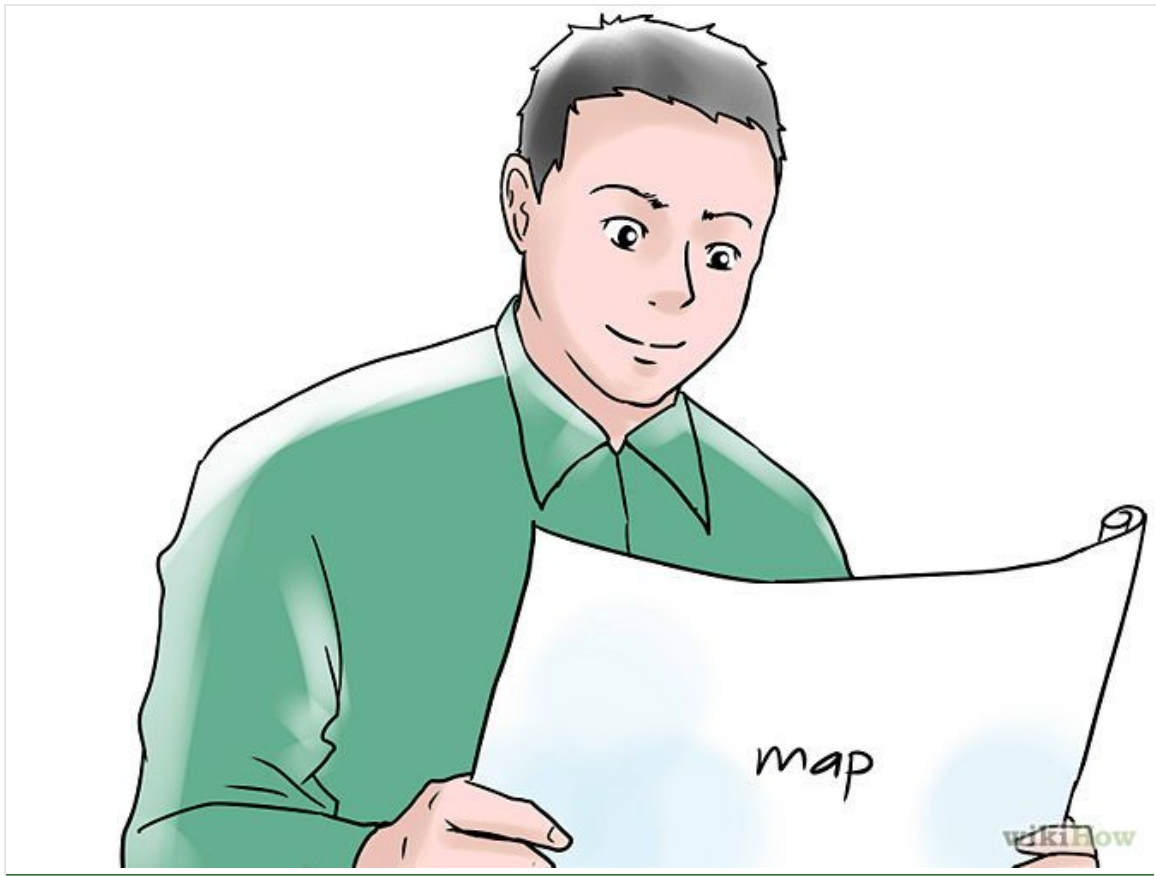

1. Obtain any necessary permits. Your local government may have building and zoning regulations that regulate fence setbacks, type and height.



2. Establish where your property lines are located. This information can be obtained from city records, a realtor's line plot map or by hiring a surveyor.



.           3. Call from anywhere in your local. Your local utility companies will then send an employee to mark your utility lines for free. You don't want to accidentally hit them while digging post holes.

.

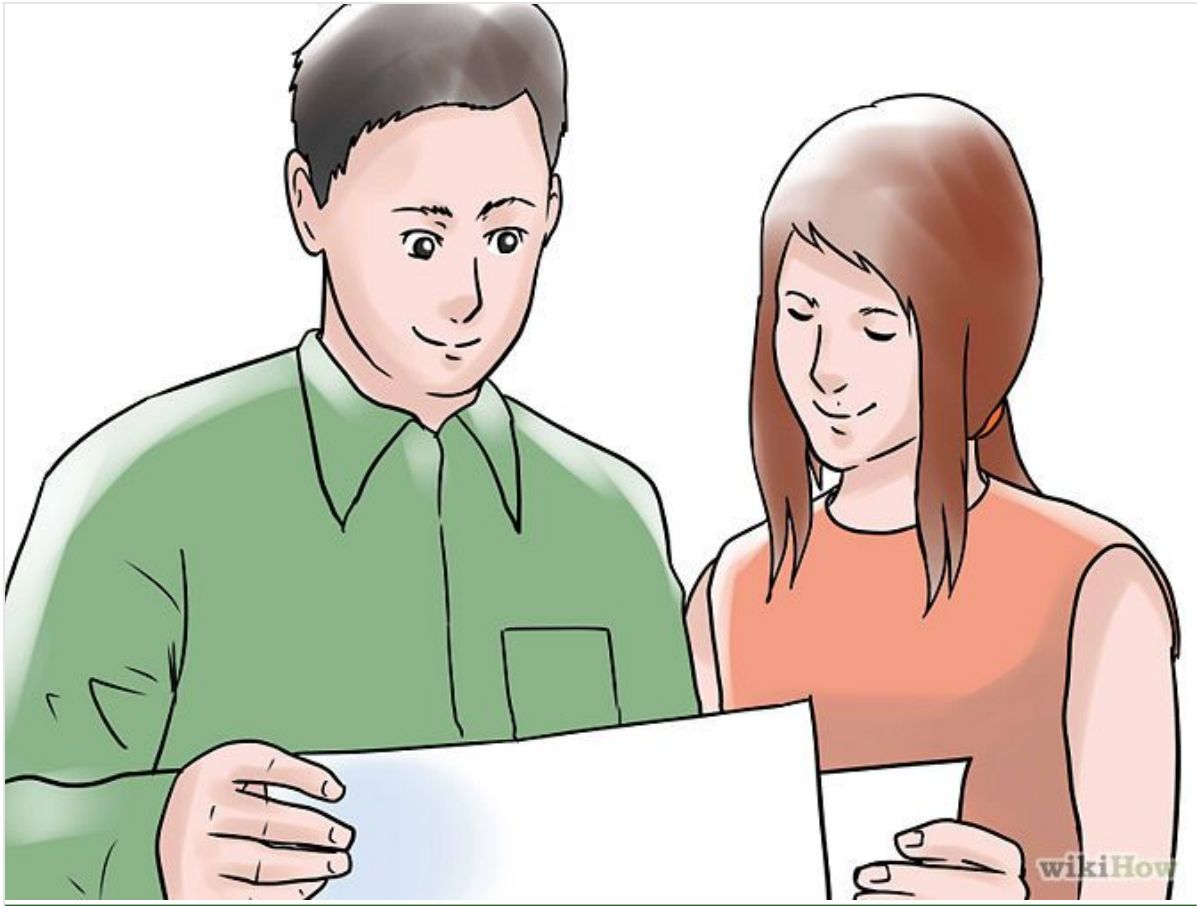

4. Review any neighborhood covenants for regulations on fencing. Some neighborhood associations have their own rules regarding height and style, additional to the rules enforced by your town.

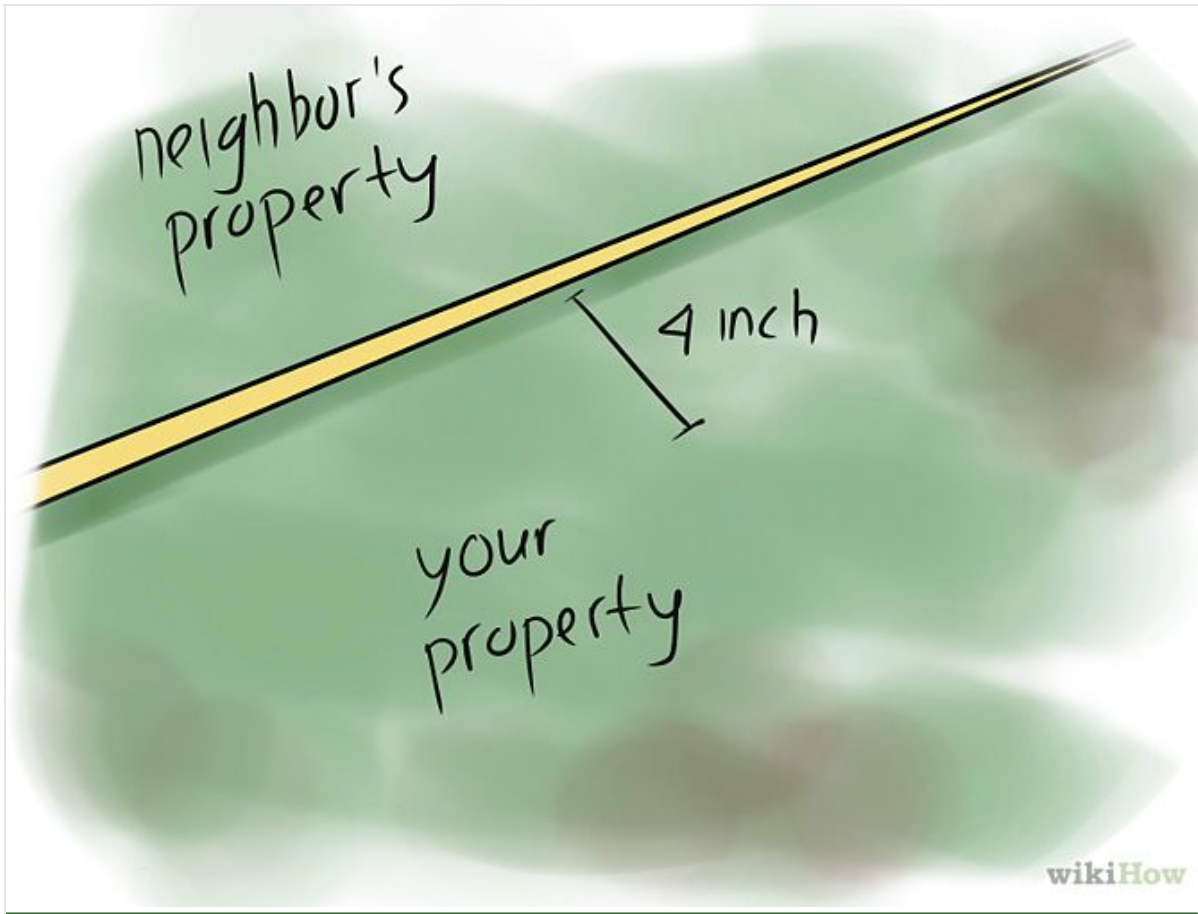

1. Locate the property lines that border your neighbor's. For your post holes, measure approximately 4 inches inside those lines. This prevents the concrete footings from encroaching onto your neighbor's property.



2. Measure the total length of your planned fence. This determines how many feet of chain-link mesh and the amount of hardware you'll need. Consult your local retailer for post spacing guidelines to determine the number of posts you'll need.



3. Find each terminal post location. Mark the exact spot with a stake or spray paint. A terminal post refers to any end, corner or gate posts.

### Method 3 of 11: Install the Terminal Posts



1. Dig all the terminal post holes first. Post holes should be dug 3 times the width and one-third the length of the post, with an extra 4 inches for gravel. Slope the sides so that the hole is wider at the bottom than at the top.





2. Fill the post holes with 4 inches of gravel. Tamp down the gravel to provide a compact foundation for the posts and concrete.



3. Stand a terminal post in the center of its hole. Mark the side of the post at ground level using a marker or chalk. The height above the line should equal the height of the fence mesh, plus 2 inches.

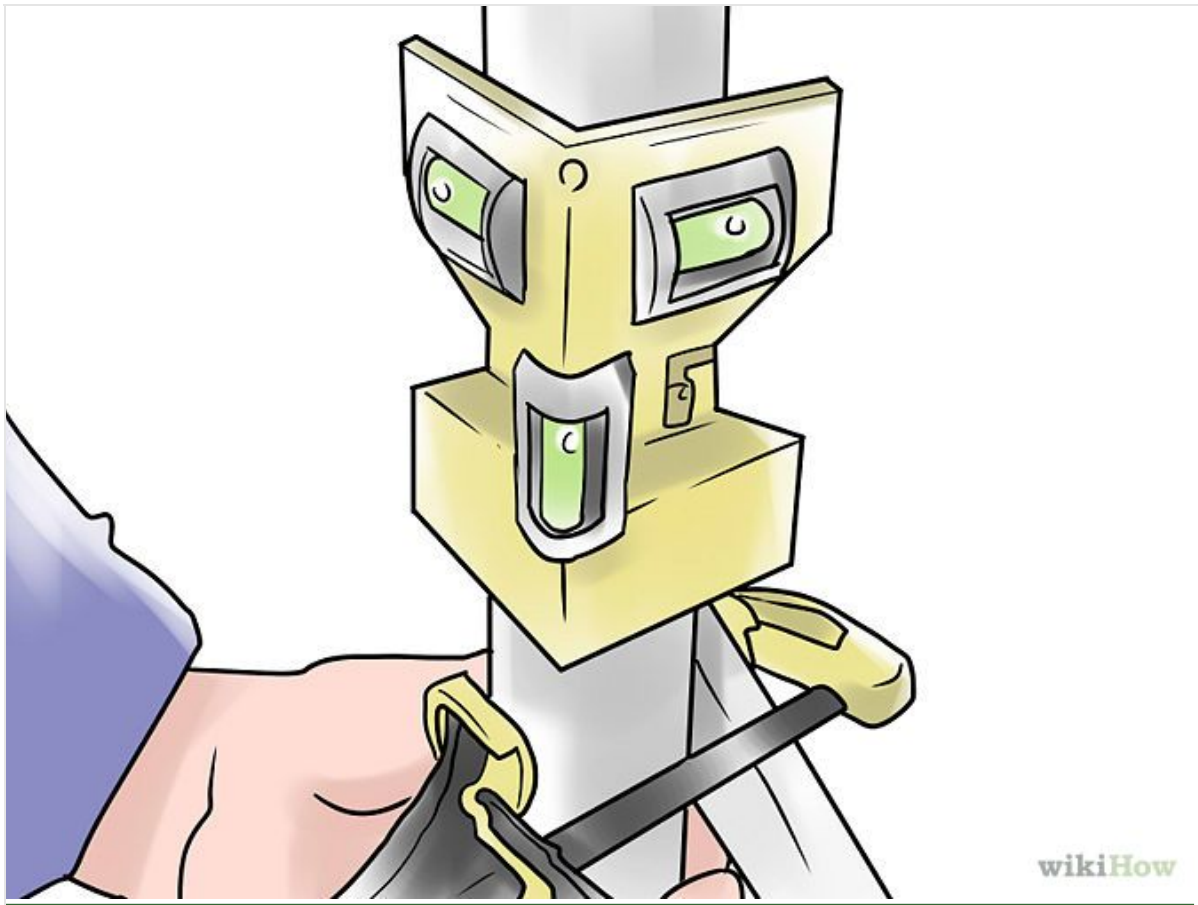

4.Plumb the post. Using a carpenter's level or plumb line, position the post until its plumb.

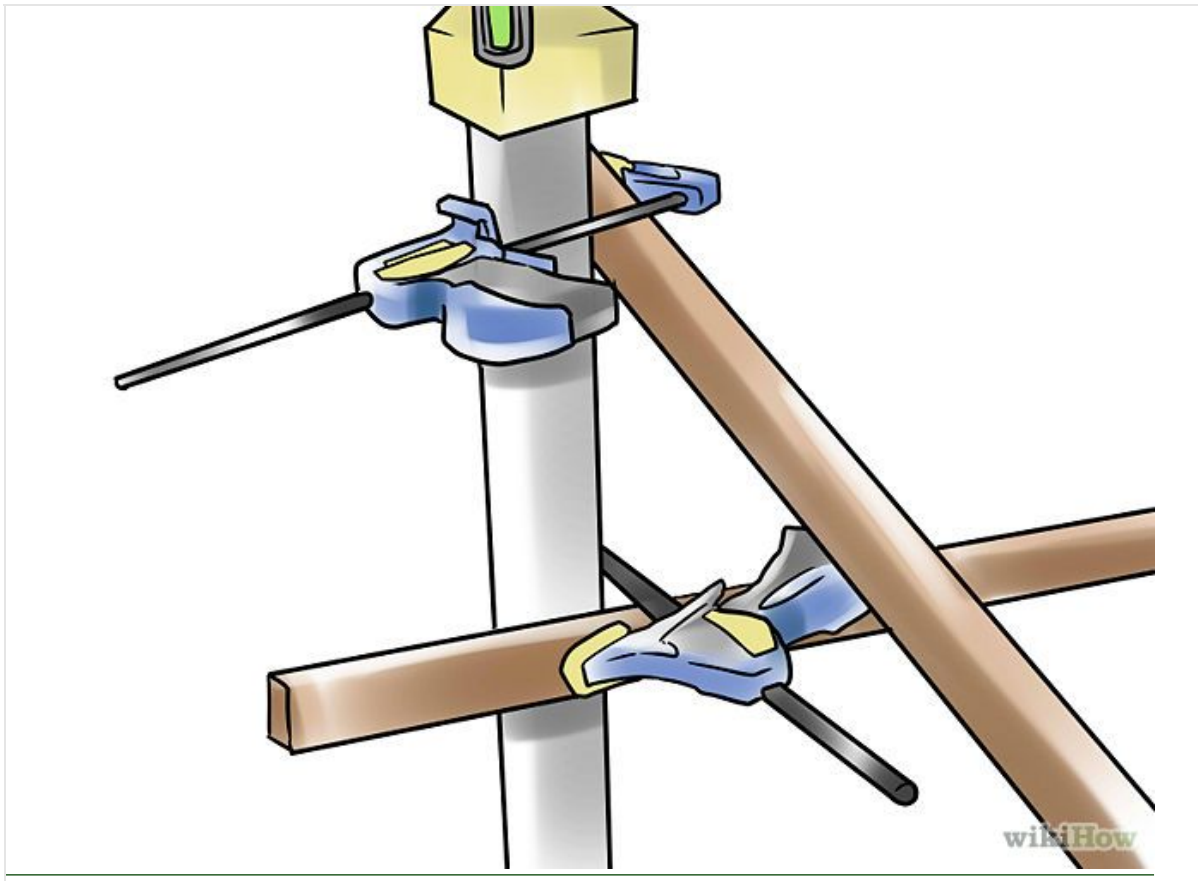

5. Secure the post in position. Using clamps and pieces of lumber angled into the ground, brace the post in its plumb position.

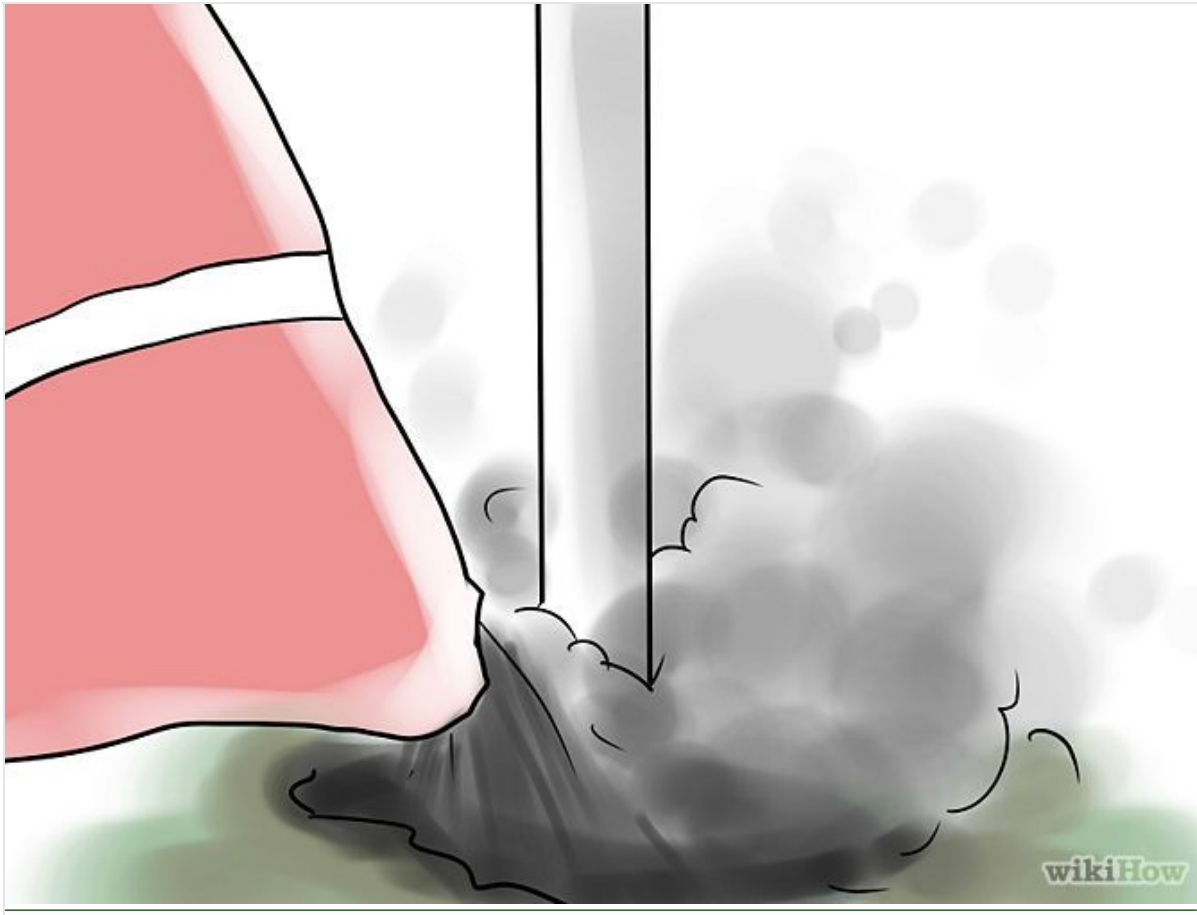

6. Fill the hole with concrete. Pour or shovel concrete around the post. Smooth the surface with a trowel or small piece of wood, sloping away from the post to direct water elsewhere.



7.Repeat until all your terminal posts are installed. Allow time for the concrete to set, according to manufacturer's recommendations.

#### Method 4 of 11: Mark Your Line Posts

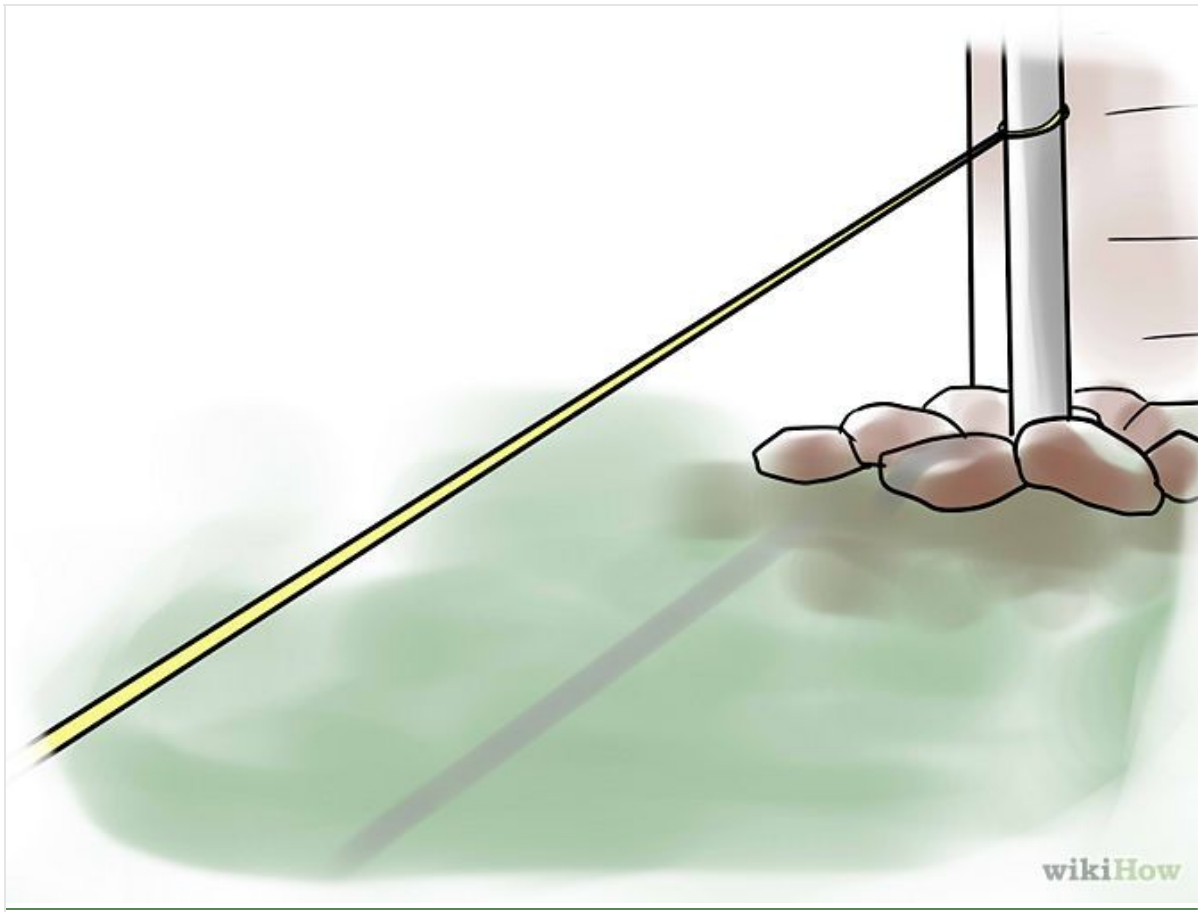

1. Run a string line between the terminal posts. The string should be taut, low to the ground, and positioned on the outside face of the terminal posts.

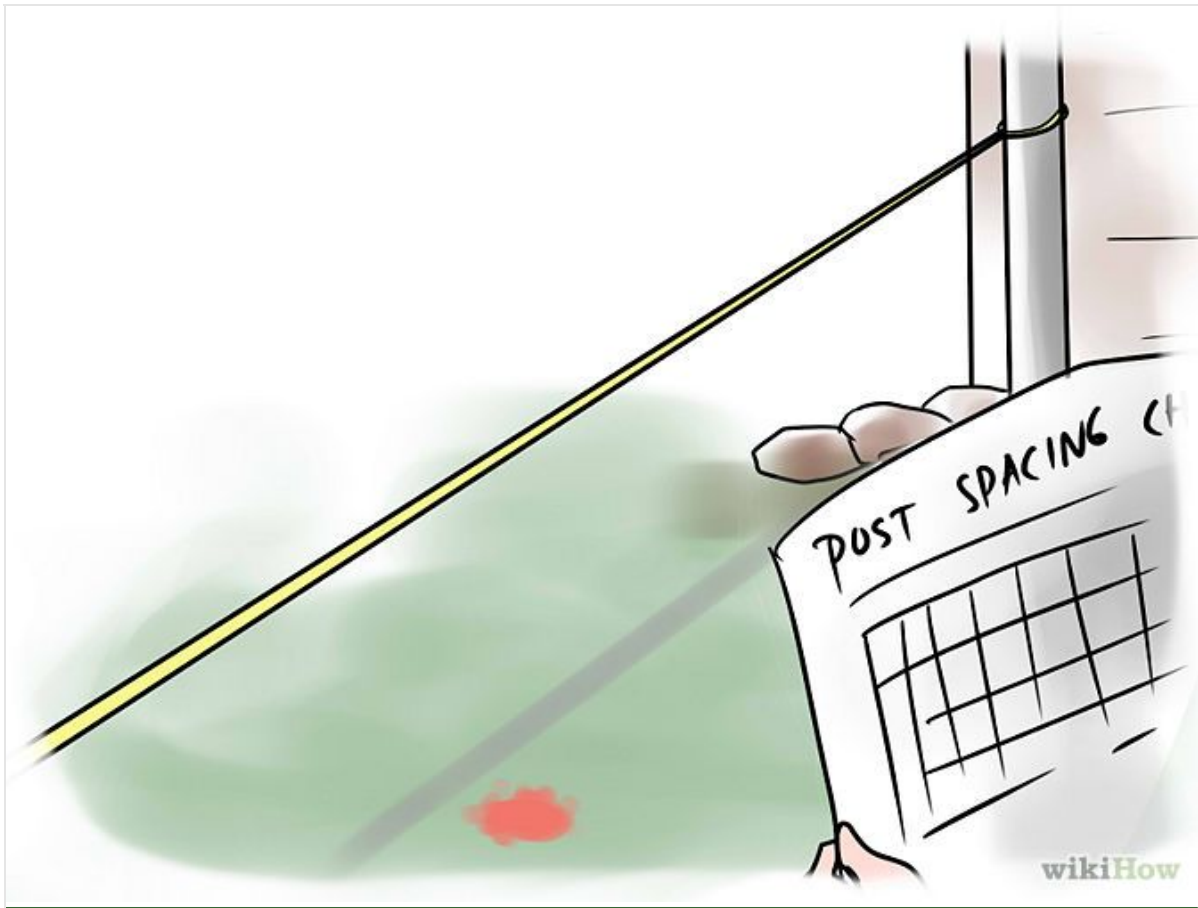

2. Mark the location of each line post. Using a post spacing chart, measure and mark the exact spot with a stake or spray paint.

## Method 5 of 11: Install the Line Posts





1. Dig the line post holes. Line post holes should be 6 inches wide and 18 inches to 24 inches deep, with sloping sides.

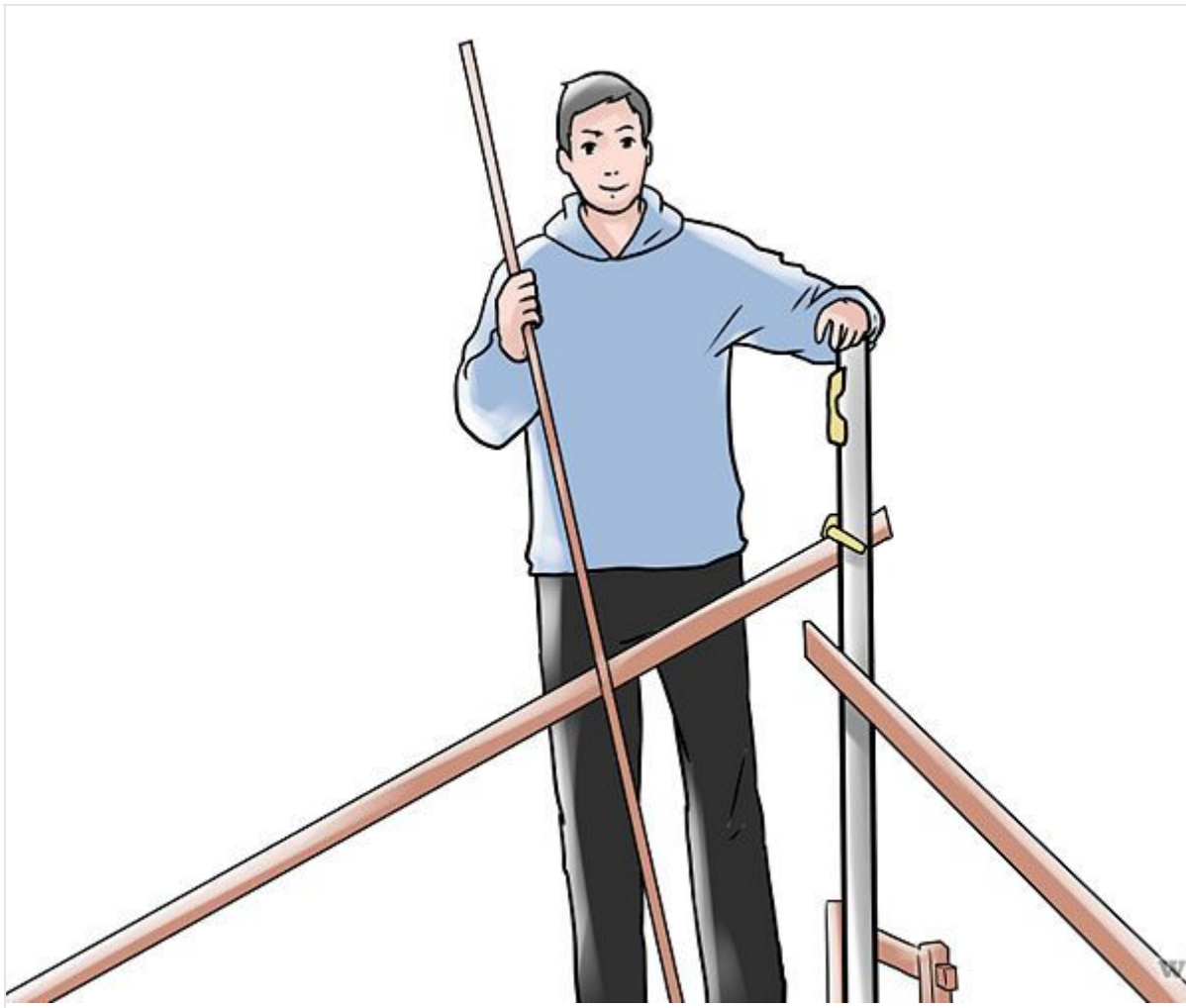

Repeat the terminal post installation steps (above) for each line post.

### Method 6 of 11: Install The top rail

Each post was punching hole already . Use the U type Clamp fixed the top rail with the post at the top and bottom, like the photo,then tightening the screws.



Method 7 of 11: Use The Top Rail Sleeves connect the two top rails. The top rail and the rail sleeves are all punching the hole, use the M8\*45mm screws fixed them, Tighten all the nuts and bolts, but not too tight. Leave some slack for adjustments.

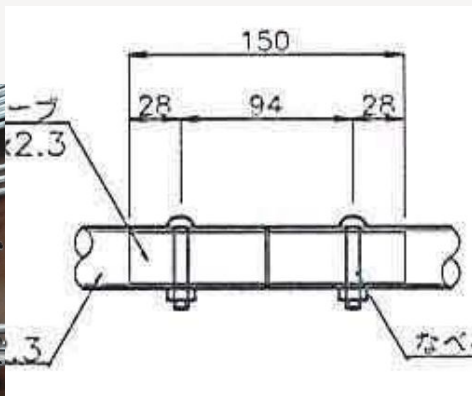

## Method 8 of 11: Hang the Chain link Fence Mesh

1. Slide a tension bar vertically through the starting end of the mesh roll. This will stiffen the mesh so that you can attach it to the fence posts and rails.

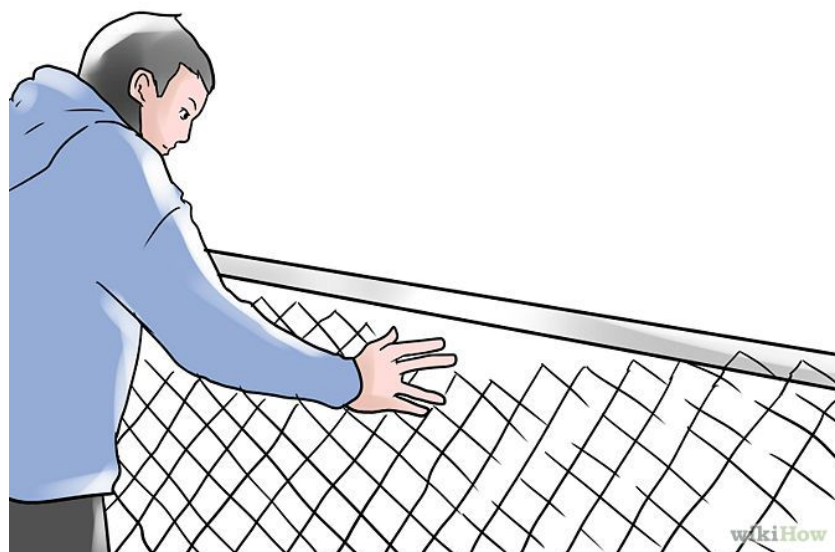
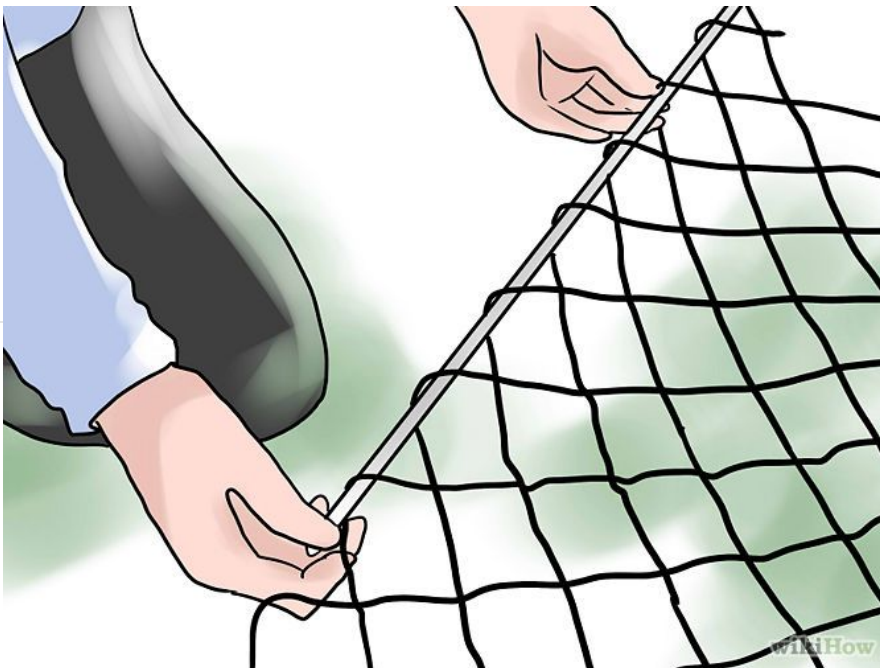

## 2.Add tension wire

Tie the 4.0mm tension wire at the tension bar,then fixed the tension bar and the wire by the tension wire clamp.Using the M8\*85mm screws tighten them.

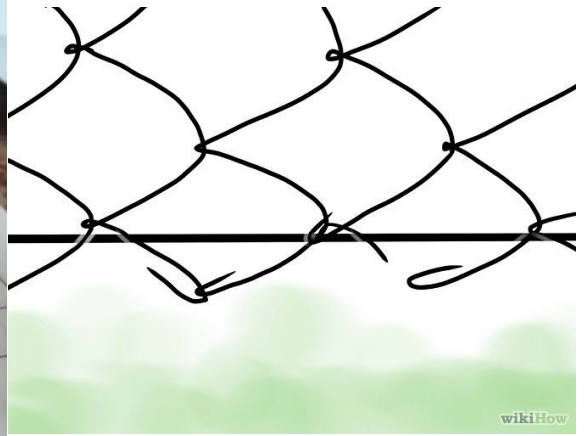

b 部詳細図 S=1:8

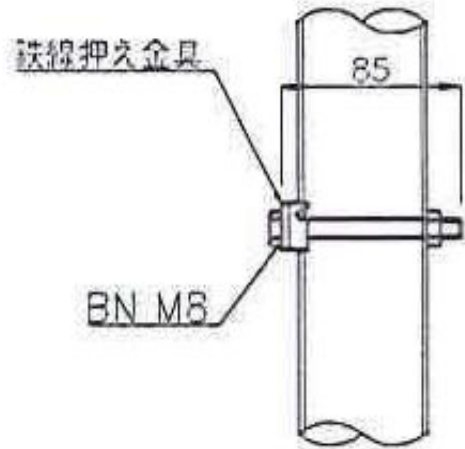
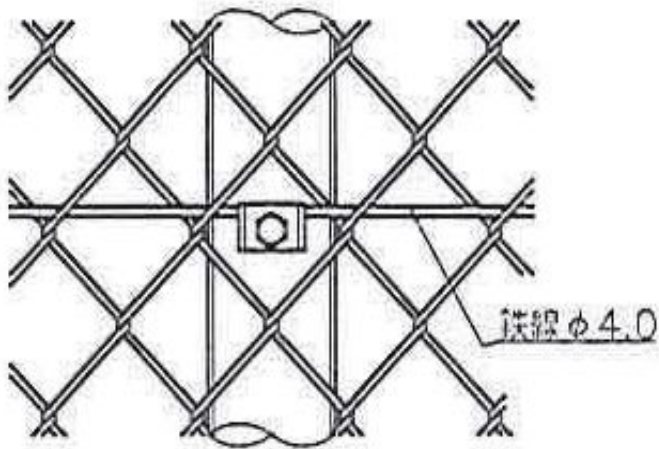

3.Begin unrolling the mesh. Stand it up against the fence frame, taking out the tie wire as you go.(Cut the 2.8mm tie wire to 15-20cm length )

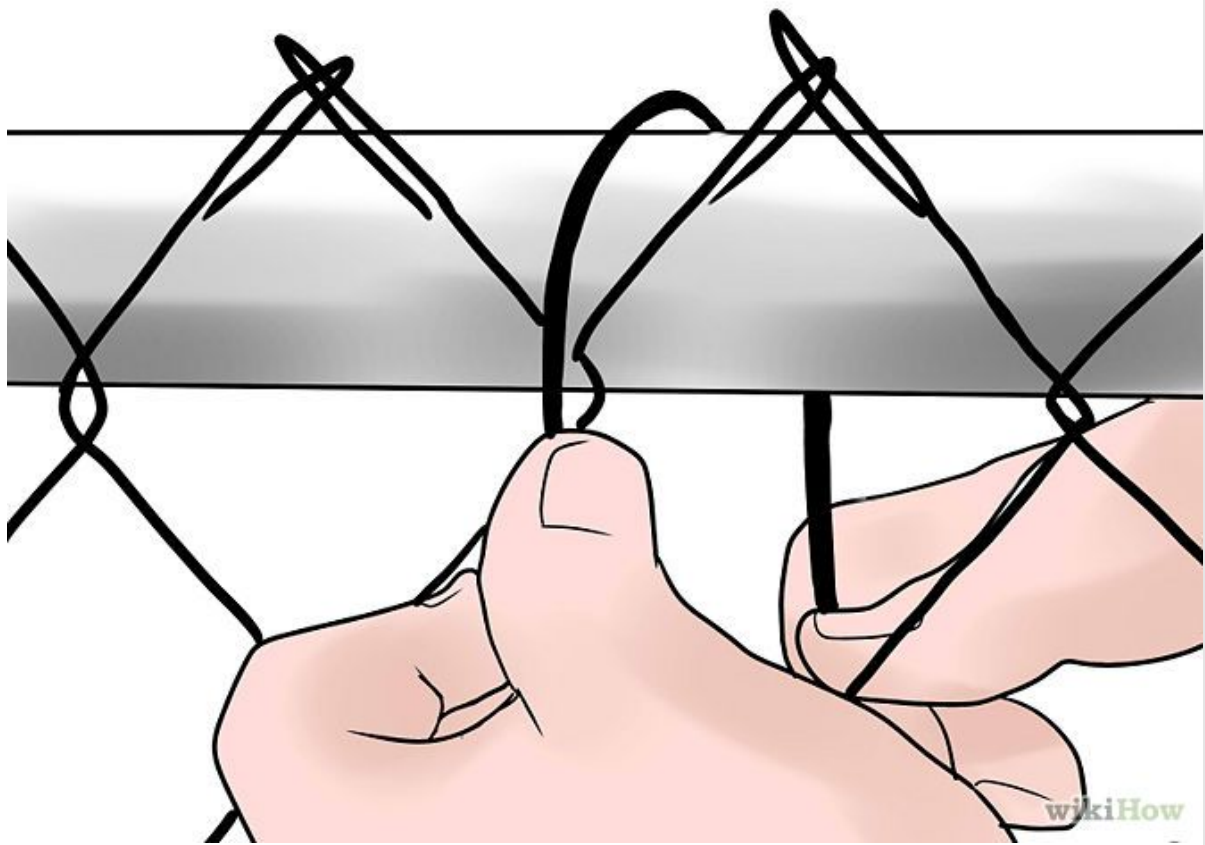

Loosely attach the mesh to the top rail. Use fence ties to hold it in place. Separate enough length from the roll to span the opening between the terminal posts.

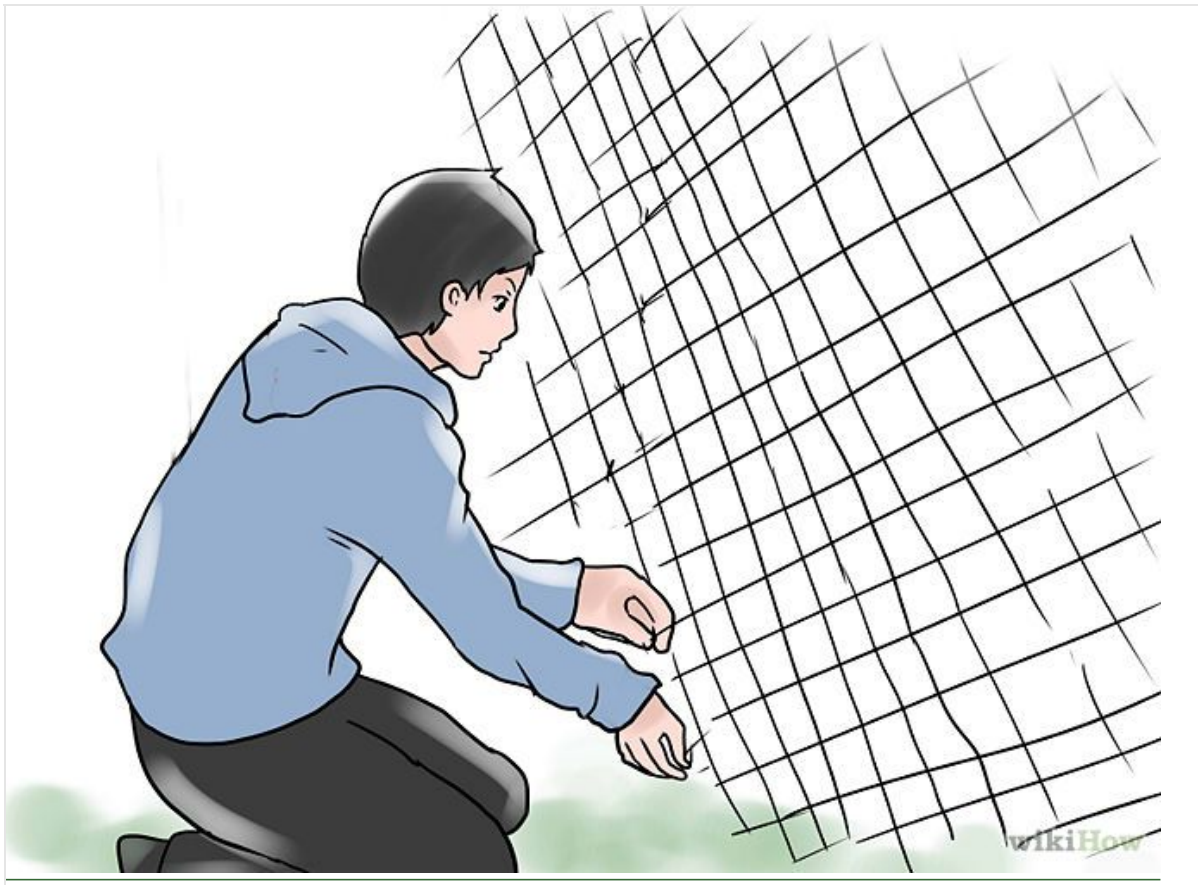

5. Splice sections together as needed. Using a single strand of wire removed from one end of the mesh, join two sections by corkscrewing the loose strand through the end links. A second strand may have to be removed to provide the correct line-up of "diamonds."

Remove excess mesh. Using pliers, untwist the top and bottom loops on one strand of wire where you want to separate the mesh. Work the freed strand out of the links until the two sections separate.



5.Remove any new excess produced by stretching.

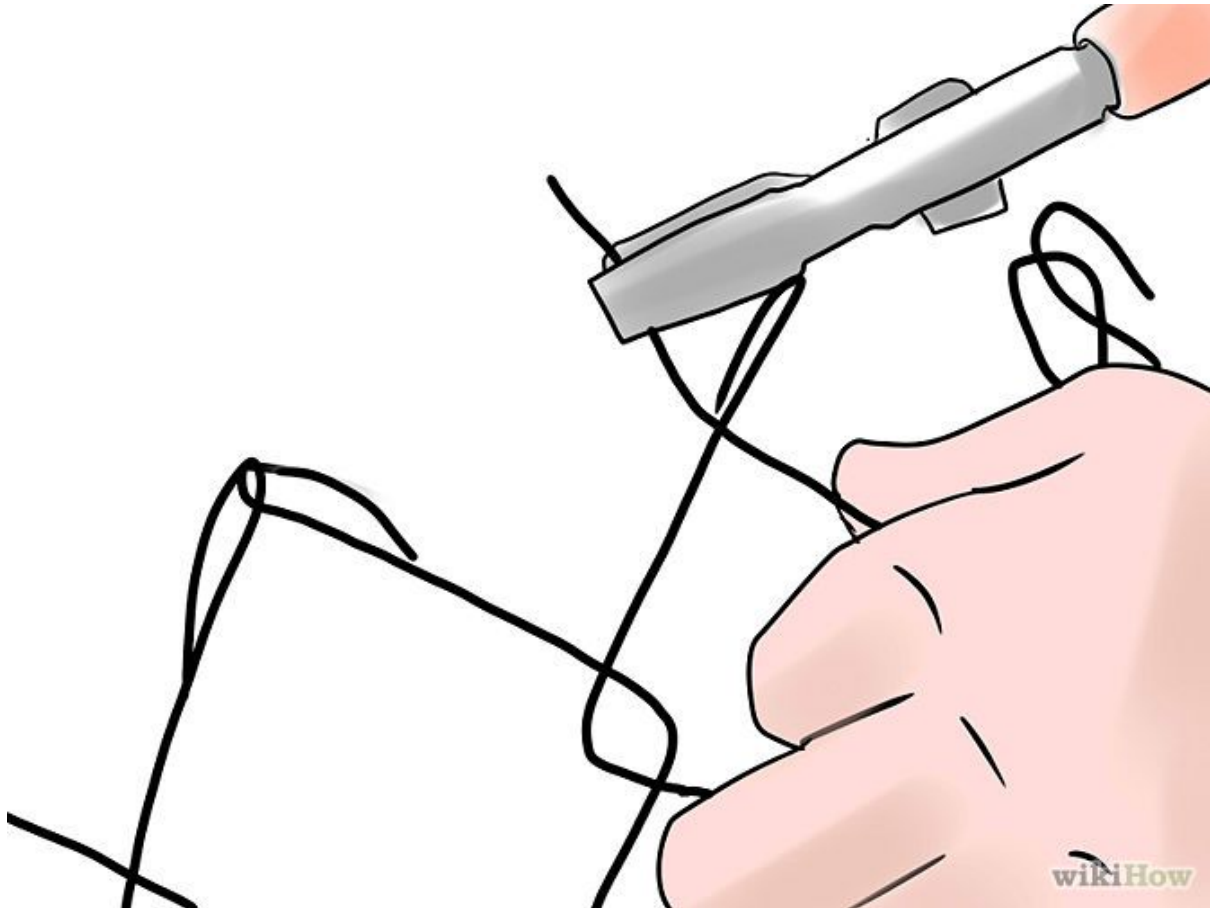

**The finished Chain link fence like the following picture and drawing. Tight all the screws ,bolts ans wire.**

